

**MAN800A**

**Models 80800A  
80800A-10**

# **Mouse Forced Exercise Walking Wheel System**

## *User's Manual*

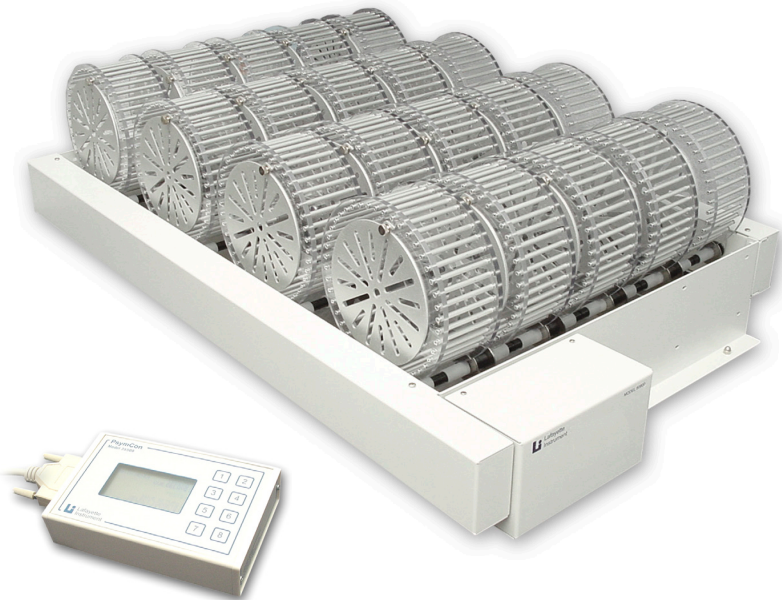

**Lafayette  
Instrument.**

3700 Sagamore Parkway N  
Lafayette, IN 47904 USA  
Tel: (765) 423-1505 • (800) 428-7545  
Fax: (765) 423-4111  
[info@lafayetteinstrument.com](mailto:info@lafayetteinstrument.com)  
[www.lafayetteinstrument.com](http://www.lafayetteinstrument.com)

# Mouse Forced Exercise Walking Wheel System

---

## Table of Contents

System Description	2
System Specifications	2
Features	3
System Parts	3
Connections	3
General Care and Troubleshooting	3
Basic Test Steps	5
Loading and Unloading Animals	5
Mouse Exercise Walking Wheel	5
Menu Descriptions	5
PsymCon Device Contrast Adjust	10
User Notes	11

## System Description

The Forced Exercise Walking Wheel System for Mice is an electronically controlled motorized wheel drive apparatus. The system features up to 20 exercise wheels (10 for the 80800A-10 model), each with the capacity for holding one mouse or other small animal. The wheels are driven by a variable speed motor, forcing the animals to perform walking or running exercise tasks. The system is designed to give maximum flexibility in conducting sleep deprivation and forced exercise studies. The system also features an integrated electronic control panel that allows the programming of a wide range of parameters including: exercise time, resting time, number of cycles and exercise wheel speed. An integrated USB port allows computer control where by the parameters of the test can be scheduled via the Scurry software.

## System Specifications

Wheel capacity:	20 (80800A) or 10 (80800A-10)
Speed range:	0.9 m/min to 11.4 m/min
Speed resolution:	0.1 m/min
Test Time Range:	0-24 hours
Rest Time Range:	0-24 hours
Timing Resolution:	1 second.
Repeat cycle limit:	999 cycles (also has continuous repeat setting)
Power:	15 VDC, 4.6A power pack (included)
Dimensions:	33.90" x 22.25" x 10.88" (with wheels)
Weight:	25.0 lbs. (empty), 41.0 lbs. (with 20 wheels)

### Use with Model 80801 wheels

- Wheel Diameter: 5.94" ID
- Wheel Width: 2.25" ID
- Run distance: 0.47 meters/revolution

### Use with Model 80803 Water Support (optional)

- Only available for Model 80800A - MAXIMUM 12 Wheels

## Features

- Twenty exercise wheel capacity (10 for the 80800A-10 model)
- Menu driven controls with graphical LCD
- Optional computer control
- Variable speed ranges with electronically controlled speed regulation
- Speed ramping functions for soft start and stop
- Timed test and rest times with repeat cycle setting
- Microprocessor based precision timing
- Infinite repeat cycle setting
- Test setup parameter storage
- Remote start ability
- Removable stainless steel waste pan
- Individual drive tracks for each wheel
- Non-slip cushioned wheel drive hubs
- Easy placement and removal of wheels (even while running)
- Easily mounted to a flat surface or workbench
- Easily disassembled for cleaning

## System Parts

- Exercise Bed with integrated drive motor
- Stainless Steel Waste Pan
- Psymcon control with cable
- 15 VDC power supply with power cord
- USB cable
- Exercise Wheels (Model 80801 – purchased separately)
- User Manual

## Connections

### To set up the Forced Exercise Bed

1. Connect the power cord to the 15V power supply
2. Connect the 15V power supply to the Exercise Bed
3. Connect the Psymcon control unit to the Exercise Bed with the 25 pin cable.
4. For computer control, connect the USB cable to the Exercise Bed "Computer" port. Connect the other side of the cable to an available USB port on the computer (Scurry software required – purchased separately)

## General Care and Troubleshooting

### Care Instructions

- Make sure shafts are free of debris
- Make sure screws are tight
- Make sure wheels are setting fully on the rollers and not running off of them
- Make sure there is not a thumping sound when it runs and that all shafts spin properly

# Mouse Forced Exercise Walking Wheel System

## Troubleshooting Instructions

- If there is a thumping noise or shafts are not spinning properly:
  - Open the side of the exercise bed
  - Make sure belts are free of debris and not rubbing against metal
  - Make sure screws are tight, especially on pulleys. A 5/64" or 2mm hex key may be used on the set screws on the pulleys.
  - Make sure the belts have sufficient tension to avoid slipping on the pulleys. (This would cause a thumping noise.)

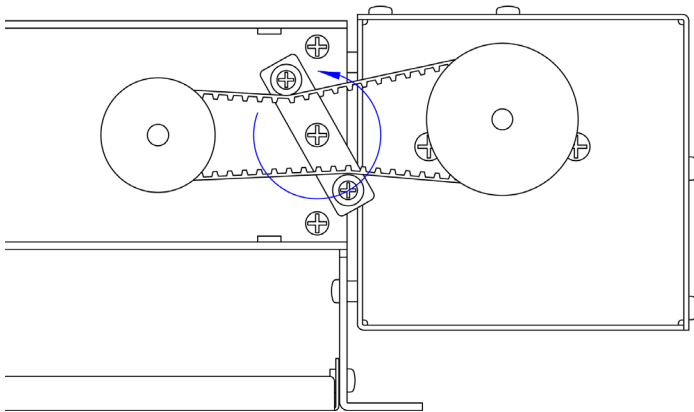
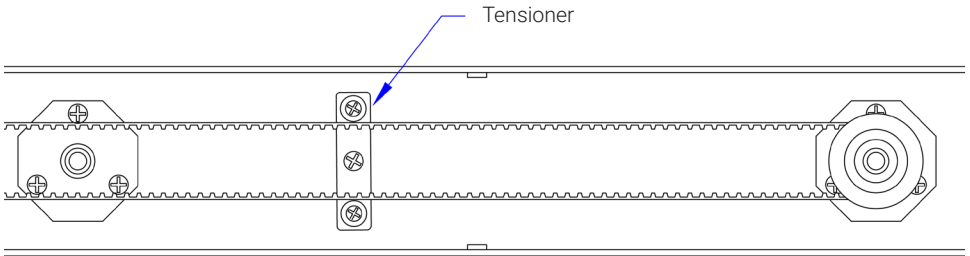

Turn Tensioner counter-clockwise to increase belt tension. Be sure to tighten center screws when finished.

## Basic Test Steps

After the unit is assembled and power is applied, a test can be run. A typical test will have the following steps. See the section on menu descriptions for special instructions on each of the steps.

### From the Speed Menu

1. Select the exercise speed for the test

### From the Duration Menu

1. Select the "Test Time" for each test
2. Select the "Rest Time" for each test

### From the Cycles Menu

1. Select the number of times to repeat the test

### From the Test Menu

1. Start, Stop, and Reset the Test.
2. Press the "STATUS" button to see time and distance for the test.

## Loading and Unloading Animals

To load an animal into the wheel, loosen the thumbscrew on the swing hatch and swing the hatch away. Place the animal in the wheel, swing the hatch back to cover the wheel and tighten the thumbscrew. Place the wheel in an open track on the Forced Exercise Bed. The wheels can be loaded or unloaded while the test is in progress, if desired.

## Mouse Exercise Walking Wheel Model 80801

### Wheel Features

- Wheels are 2.25" internal width with an internal running diameter of 5.94"
- Wheels are sturdy yet lightweight
- Wheel sides are polycarbonate plastic with riveted anodized aluminum round rungs
- Thumbscrew locking swing hatch is made from anodized aluminum
- Access for animal loading and removal is 5.0"



### Wheel Specifications

Weight: 0.8lbs.

Wheel Diameter: 5.94" ID

Wheel Diameter: 6.75" OD

Wheel Width: 2.25" (internal)

Wheel Width: 2.75" (external)

## Menu Descriptions

### Using the Menus

All menus are controlled using the eight buttons to the right of the display screen. The display shows all options for a particular menu on the right side of the screen with a number label corresponding to the button number assigned to that function. Not all menus use all of the buttons. If a number label is missing on a menu, that button has no function for that particular menu.

# Mouse Forced Exercise Walking Wheel System

## Main Menu

The Main Menu runs automatically after the introduction screen. It is the default screen for all operations. All Exercise Bed functions and settings are accessed from this menu.

### Menu controls

- Button 1: Go to the Speed Menu (SPEED)
- Button 2: Go to the Duration Menu (DURATION)
- Button 3: Go to the Repeat Cycle Menu (CYCLES)
- Button 4:
- Button 5: Go to the Test Menu (TEST)
- Button 6:
- Button 7:
- Button 8: Save all setup parameters (SAVE SETUP)

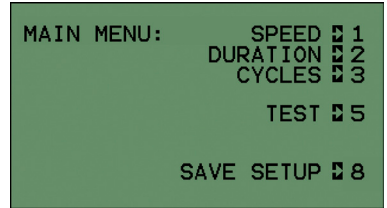

### Save Setup

This selection allows the user to store system parameters in memory. These parameters are loaded automatically the next time the device is turned on, eliminating the need to set the parameters after every power up.

### To save setup parameters

Press Button (8) in the Main Menu

Parameters saved: Test Time, Rest Time, Repeat Cycle setting, Infinite Repeat Setting and Speed setting

## Speed Menu

The Speed Menu is used to set the exercise speed of the test in meters per minute (m/min). A secondary readout shows the equivalent seconds per revolution (sec/rev) of the exercise wheels. The sec/rev reading updates as the m/min setting is changed but cannot be directly manipulated.

### To access the Speed Menu

Press Button (1) from the Main Menu

### Menu controls

- Button 1: Increment Speed by 0.1 m/min (+0.1)
- Button 2: Decrement Speed by 0.1 m/min (-0.1)
- Button 3: Increment Speed by 1.0 m/min (+1.0)
- Button 4: Decrement Speed by 1.0 m/min (-1.0)
- Button 5: Increment Speed by 5.0 m/min (+5.0)
- Button 6: Decrement Speed by 5.0 m/min (-5.0)
- Button 7:
- Button 8: Enter speed and return to Main Menu (ENTER)

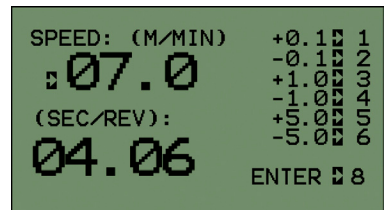

## Notes

- The menu automatically limits the speed range per the gear ratio settings. It will not allow speed settings higher or lower than the specified limits.
- Only one speed may be used for the test. If a speed change is desired during a test, it must be done manually. More complex speed changes can be programmed when using the optional computer control software.
- The system automatically adjusts itself to maintain a constant speed if wheels are added or subtracted. Slight speed variation may be noticeable during the adjustment period.

## Specifications

Default Gear Ratio (28/18)

- Max speed: 11.4 m/min
- Min speed: 0.9 m/min

Alternate Gear Ratio (28/10)

- Max speed: 21.0 m/min
- Min speed: 1.8 m/min

\* See gear ratio section for details on the alternate gear ratio (page 9).

## Duration Menu

The Duration Menu is used to set the Test and Rest Time for the test. The shadowed cursor indicates which selection is active. Only the active selection is changed by the buttons. Both times are represented in the hours:minutes:seconds (H:M:S) format. The distance setting represents the distance that will be traveled in meters for the set amount of time. The setting is based on the test time entered and the speed specified in the Speed Menu. The distance is for display only and cannot be directly manipulated.

### To access the Duration Menu

Press Button (2) in the Main Menu

### Menu controls

- |                                                |          |
|------------------------------------------------|----------|
| Button 1: Increment the time by 1              | (+1)     |
| Button 2: Decrement the time by 1              | (-1)     |
| Button 3: Increment the time by 10             | (+10)    |
| Button 4: Decrement the time by 10             | (-10)    |
| Button 5: Go to Maximum setting                | (MAX)    |
| Button 6: Go to Minimum setting                | (MIN)    |
| Button 7: Advance the Cursor to the next value | (SELECT) |
| Button 8: Enter time and return to Main Menu   | (ENTER)  |

```
TEST TIME:      +1 1
                -1 2
                +10 3
DISTANCE:      -10 4
                MAX 5
                MIN 6
RESET TIME:    SELECT 7
                00:10:00  ENTER 8
```

## Notes

- The menu automatically limits the settings for the duration range. The maximum range is 23 hours, 59 minutes and 59 seconds.
- The test time is always executed first, followed by the rest time. If the repeat cycle is set to 1, the rest time is ignored and the test ends after the test time.
- An entry of zero for the test time or rest time will automatically be changed to 1 second.

# Mouse Forced Exercise Walking Wheel System

## Cycles Menu

The Cycles Menu is used to set the repeat cycles for the test. One cycle consists of one test period and one rest period as specified in the Duration Menu. The test may be set for infinite cycles. In this case, the test and rest time cycle will repeat until stopped by user intervention.

### To access the Cycles Menu

Press Button (3) in the Main Menu

#### Menu controls

- Button 1: Increment the cycles by 1 (+1)
- Button 2: Decrement the cycles by 1 (-1)
- Button 3: Increment the cycles by 10 (+10)
- Button 4: Decrement Speed by 10 (-10)
- Button 5: Increment the cycles by 100 (+100)
- Button 6: Decrement the cycles by 100 (-100)
- Button 7: Toggle infinite repeat on/off (INF. REP)
- Button 8: Enter cycle and return to Main Menu (ENTER)

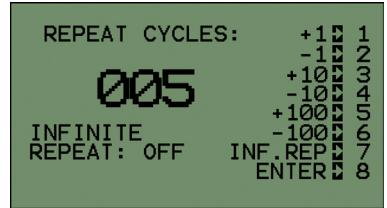

**Note:** The maximum number of cycles is 999 unless the infinite repeat is set.

## Test menu

The Test Menu allows the test to execute as determined by the setup parameters. The Test Menu displays the setup parameters and provides control buttons for the test. It also shows a status bar that indicates the progress of the test.

### To access the Test Menu

Press Button (5) in the Main Menu.

#### Menu controls

- Button 1:
- Button 2:
- Button 3:
- Button 4:
- Button 5: Start/Stop the test (START/STOP)
- Button 6: Reset the test (RESET)
- Button 7: Go to the Status Menu (STATUS)
- Button 8: Return to the Main menu (MENU)

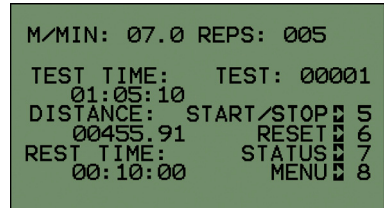

See "Important Instructions for Running Tests" for operational rules (page 10).



## Status Menu

The Status Menu shows the current statistics for the test. This includes the cycle time, cycle distance, total test time and total distance. Each of these four readouts update as the test is in progress. The cycle readouts reset after each test time. The total time and distance indicators can only be reset by pressing the "Reset" button. The Status Menu allows the same control over the test as the Test Menu (Start, Stop, and Reset).

### To access the Status Menu

Press Button (7) in the Test Menu.

### Menu controls

Button 1:

Button 2:

Button 3:

Button 4:

Button 5: Start/Stop the test (START/STOP)

Button 6: Reset the test (RESET)

Button 7: Go to the Test Menu (TEST)

Button 8:

```
CYC. TIME: 00:00:15
CYC. DIST: 00001.36 -- IDLE --
TOT. TIME: 00:00:15 START/STOP 5
                RESET 6
TOT. DIST: 00001.36 TEST 7
                ENTER 8
```

## Important Instructions for Running tests

- To Start a test, Press "Start" in the Test Menu or Status Menu.
- Once the test is running, the "Start" button becomes the "Stop" button.
- Pressing the "Stop" button will pause the test. The test can be resumed by pressing the "Start" button again or cancelled by pressing the "Reset" button.
- The test resumes exactly where it was paused with respect to time, distance, and cycles.
- Canceling a test resets the time and distance readouts. The test will then begin from zero on the next "Start" command.
- The user can toggle between the Test Menu and the Status Menu while the test is running.
- The control will always ramp the speed up and down on a start or stop. The length of the ramp time depends on the speed setting. The ramp time is not included in the time or distance reading. The time for the test will start once the wheel has reached its full speed.

## Remote Initiate

A test may be started remotely by another hardware device. A switch closure on the Remote Initiate jack on the control head will initiate a test. The Remote Initiate input provides identical function as pressing the Start button in the Test Menu (see Important Instructions for Running Tests).

## Notes on Computer Operation

- See the software user manual for instructions on operating the software.
- Plugging in the USB cable will cause the Psymcon control panel to go blank.
- After unplugging the USB cable, the Psymcon screen will refresh. The system will load the parameters stored in memory (see SAVE SETUP section). It will not continue to use the parameters downloaded from the computer.

# Mouse Forced Exercise Walking Wheel System

---

## PsymCon Device Contrast Adjust

The PsymCon Device's LCD display has an adjustable contrast setting. In the event that the LCD screen is too faint to see or the background is too dark, the user can adjust the contrast. To adjust, use a small flathead screwdriver to turn the internal dial on the PsymCon control panel. The adjustment dial is on the left side of the control box beside the cable entry port for the device.

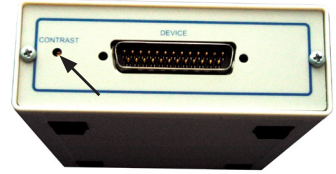

## **User Notes**

Enter any user notes here for your convenience.

# Terms and Conditions

## LIC Worldwide Headquarters

Toll-Free: (800) 428-7545 (USA only)  
Phone: (765) 423-1505  
Fax: (765) 423-4111  
sales@lafayetteinstrument.com  
export@lafayetteinstrument.com (Outside the USA)

## Mailing Address:

Lafayette Instrument Company  
PO Box 5729  
Lafayette, IN 47903, USA

## Lafayette Instrument Europe

Phone: +44 1509 817700  
Fax: +44 1509 817701  
Email: eusales@lafayetteinstrument.com

## Phone, Fax, Email or Mail-in Orders

All orders need to be accompanied by a hard copy of your purchase order. All orders must include the following information:

- Quantity
- Part Number
- Description
- Your purchase order number or method of pre-payment
- Your tax status (include tax-exempt numbers)
- Shipping address for this order
- Billing address for the invoice we'll mail when this order is shipped
- Signature and typed name of person authorized to order these products
- Your telephone number
- Your email address
- Your FAX number

## Domestic Terms

There is a \$50 minimum order. Open accounts can be extended to most recognized businesses. Net amount due 30 days from the date of shipment unless otherwise specified by us. Enclose payment with the order; charge with VISA, MasterCard, American Express, or pay COD. We must have a hard copy of your purchase order by mail, E-mail or fax. Students, individuals and private companies may call for a credit application.

## International Payment Information

There is a \$50 minimum order. Payment must be made in advance by: draft drawn on a major US bank; wire transfers to our account; charge with VISA, MasterCard, American Express, or confirmed irrevocable letter of credit. Proforma invoices will be provided upon request.

## Exports

If ordering instrumentation for use outside the USA, please specify the country of ultimate destination, as well as the power requirements (110V/60Hz or 220V/50Hz). Some model numbers for 220V/50Hz will have a "C" suffix.

## Quotations

Quotations are supplied upon request. Written quotations will include the price of goods, cost of shipping and handling, if requested, and estimated delivery time frame. Quotations are good for 30 days, unless otherwise noted. Following that time, prices are subject to change and will be re-quoted at your request.

## Cancellations

Orders for custom products, custom assemblies or instruments built to customer specifications will be subject to a cancellation penalty of 100%. Payment for up to 100% of the invoice value of custom products may be required in advance. Cancellation for a standard Lafayette Instrument manufactured product once the product has been shipped will normally be assessed a charge of 25% of the invoice value, plus shipping charges. Resell items, like custom products, will be subject to a cancellation penalty of 100%.

## Exchanges and Refunds

Please see the cancellation penalty as described above. No item may be returned without prior authorization of Lafayette Instrument Company and a Return Goods Authorization (RGA#) number which must be affixed to the shipping label of the returned goods. The merchandise should be packed well, insured for the full value and returned along with a cover letter explaining the reason for return. Unopened merchandise may be returned prepaid within thirty (30) days after receipt of the item and in the original shipping carton. Collect shipments will not be accepted. Product must be returned in saleable condition, and credit is subject to inspection of the merchandise.

## Repairs

Instrumentation may not be returned without first receiving a Return Goods Authorization Number (RGA). When returning instrumentation for service, please call Lafayette Instrument to receive a RGA number. Your RGA number will be good for 30 days. Address the shipment to:

Lafayette Instrument Company  
3700 Sagamore Parkway North  
Lafayette, IN 47904, USA.

Shipments cannot be received at the PO Box. The items should be packed well, insured for full value, and returned along with a cover letter explaining the malfunction. An estimate of repair will be given prior to completion ONLY if requested in your enclosed cover letter. We must have a hard copy of your purchase order by mail or fax, or repair work cannot commence for non-warranty repairs.

## Damaged Goods

Damaged instrumentation should not be returned to Lafayette Instrument prior to a thorough inspection. If a shipment arrives damaged, note damage on delivery bill and have the driver sign it to acknowledge the damage. Contact the delivery service, and they will file an insurance claim. If damage is not detected at the time of delivery, contact the carrier/shipper and request an inspection within 10 days of the original delivery. Please call the Lafayette Instrument Customer Service Department for repair or replacement of the damaged merchandise.

## Limited Warranty

Lafayette Instrument Company warrants equipment manufactured by the company to be free of defects in material and workmanship for a period of one year from the date of shipment, except as provided hereinafter. The original manufacturer's warranty will be honored by Lafayette Instrument for items not manufactured by Lafayette Instrument Company, i.e. resell items. This assumes normal usage under commonly accepted operating parameters and excludes consumable products.

Warranty period for repairs or used instrumentation purchased from Lafayette Instrument is 90 days. Lafayette Instrument Company agrees either to repair or replace, at its sole option and free of part charges to the customer, instrumentation which, under proper and normal conditions of use, proves to be defective within the warranty period. Warranty for any parts of such repaired or replaced instrumentation shall be covered under the same limited warranty and shall have a warranty period of 90 days from the date of shipment or the remainder of the original warranty period whichever is greater. This warranty and remedy are given expressly and in lieu of all other warranties, expressed or implied, of merchantability or fitness for a particular purpose and constitutes the only warranty made by Lafayette Instrument Company.

Lafayette Instrument Company neither assumes nor authorizes any person to assume for it any other liability in connection with the sale, installation, service or use of its instrumentation. Lafayette Instrument Company shall have no liability whatsoever for special, consequential, or punitive damages of any kind from any cause arising out of the sale, installation, service or use of its instrumentation. All products manufactured by Lafayette Instrument Company are tested and inspected prior to shipment. Upon prompt notification by the Customer, Lafayette Instrument Company will correct any defect in warranted equipment of its manufacture either, at its option, by return of the item to the factory, or shipment of a repaired or replacement part. Lafayette Instrument Company will not be obliged, however, to replace or repair any piece of equipment, which has been abused, improperly installed, altered, damaged, or repaired by others. Defects in equipment do not include decomposition, wear, or damage by chemical action or corrosion, or damage incurred during shipment.

## Limited Obligations Covered by this Warranty

1. In the case of instruments not of Lafayette Instrument Company manufacture, the original manufacturer's warranty applies.
2. Shipping charges under warranty are covered only in one direction. The customer is responsible for shipping charges to the factory if return of the part is required.
3. This warranty does not cover damage to components due to improper installation by the customer.
4. Consumable and/or expendable items, including but not limited to electrodes, lights, batteries, fuses, O-rings, gaskets, and tubing, are excluded from warranty.
5. Failure by the customer to perform normal and reasonable maintenance on instruments will void warranty claims.
6. If the original invoice for the instrument is issued to a company that is not the company of the end user, and not an authorized Lafayette Instrument Company distributor, then all requests for warranty must be processed through the company that sold the product to the end user, and not directly to Lafayette Instrument Company.

## Export License

The U.S. Department of Commerce requires an export license for any polygraph system shipment with an ULTIMATE destination other than: Australia, Japan, New Zealand or any NATO Member Countries. It is against U.S. law to ship a Polygraph system to any other country without an export license. If the ultimate destination is not one of the above listed countries, contact us for the required license application forms.